

GENERAL CHARACTERISTICS		
Nominal Overall Diameter	307 mm	12 in
Nominal Voice Coil Diameter	38 mm	1.5 in
Magnet Weight	810 g	28.5 oz
Overall Weight		7.15 lbs
Flux Density		1.15 T

ELECTRICAL CHARACTERISTICS	4 Ω	8 Ω	16 Ω
Nominal Impedance	4	8	16 Ω
Rated Power	50	50	50 W
Musical Power	100	100	100 W
Sensitivity@1W,1m	98.4	98.4	97.5 db

THIELE-SMALL PARAMETERS				
		4 Ω	8 Ω	16 Ω
Voice Coil DC Resistance	R_E	6.50	6.50	12.50 Ω
Resonance Frequency	f_S	113.3	112.0	110.0 Hz
Mechanical Q Factor	Q_{MS}	6.55	7.01	6.84
Electrical Q Factor	Q_{ES}	0.93	1.05	1.26
Total Q Factor	Q_{TS}	0.82	0.92	1.06
Mechanical Moving Mass	M_{MS}	29.4	25.2	25.6 g
Mechanical Compliance	C_{MS}	67	82	83 μm/N
Force Factor	B_{XL}	8.60	10.39	13.35 Wb/m
Equivalent Acoustic Volume	V_{AS}	22.8	27.6	28.0 lt.
Maximum Linear Displacement	X_{MAX}	1.5	1.0	1.0 mm
Reference Efficiency	η_0	3.40	3.48	2.80 %
Diaphragm Area	S_D	490.9	490.8	490.9 cm ²
Losses Electrical Resistance	R_{ES}	23.2	42.5	490.9 Ω
Voice Coil Inductance @ 1kHz	L_E	0.58	0.9	1.55 mH

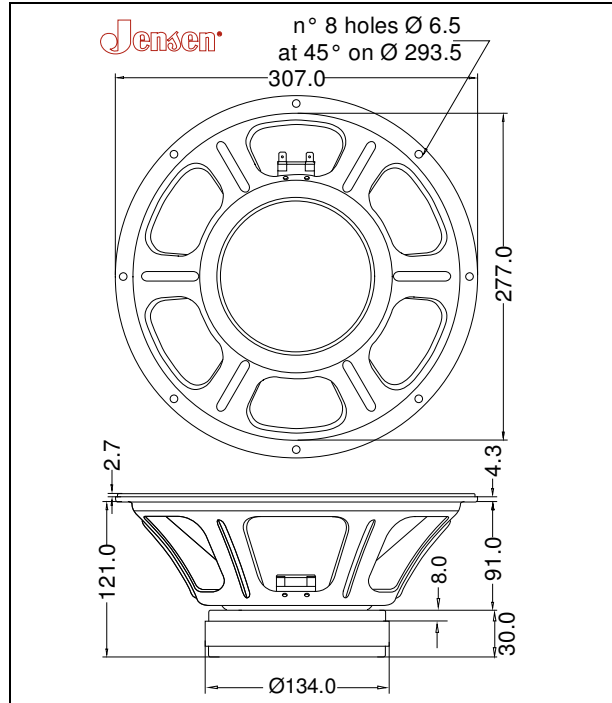

CONSTRUCTIVE CHARACTERISTICS	
Magnet	Ferrite
Voice Coil Winding	Copper
Voice Coil Former	Kapton
Cone	Paper
Surround	Integrated Paper
Dust Dome	Solid Paper
Basket	Pressed Sheet Steel

Frequency Response on IEC Baffle (DIN 45575) @ 1 W, 1 m - Free Air Impedance

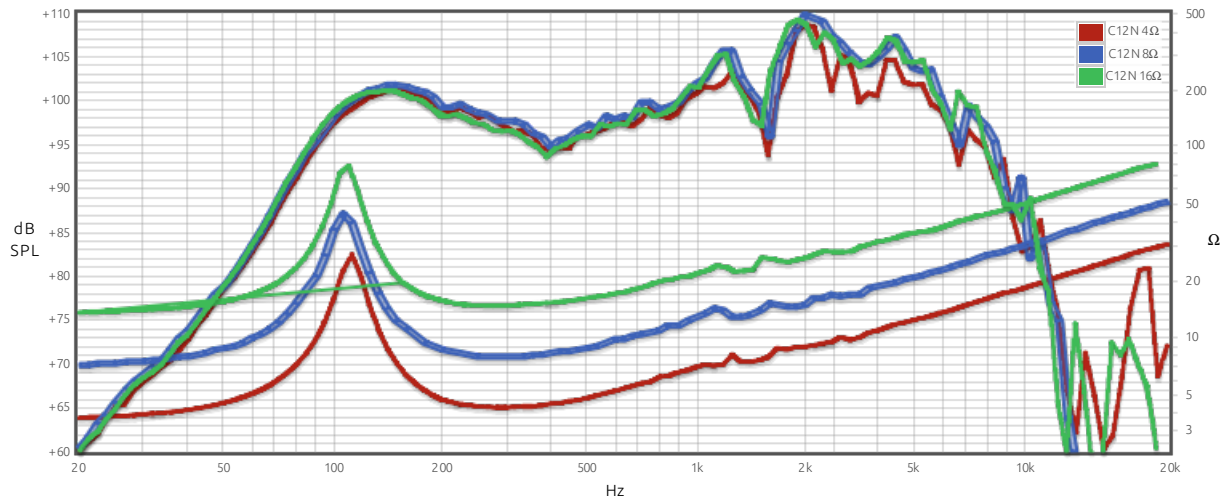

Due to continuing product improvement, the features and the design are subject to change without notice.